



Call **1800 103 2468 / 1860 500 2468** for a free demo* today
or visit **www.aosmithindia.com**



Plot No. 300, Phase - II, KIADB Industrial Area, Harohalli, Kanakapura Taluk,
Ramanagara District, Karnataka – 562 112, India. CIN: U31909KA2006PTC040282

<https://www.facebook.com/aosmithin> | <https://twitter.com/AOSmithin>

*Available only in selected cities.

AOS/NWP_R0/01/21



Water Purifiers





Say hello to A. O. Smith.

Founded in 1874 by Charles Jeremiah Smith, the A. O. Smith Corporation began as an engineering company in Milwaukee, Wisconsin. Today, we are the world's No.1 manufacturer of water heaters. This drives our pursuit for excellence when it comes to water purifiers as well. For the past 145 years, our singular purpose has been to create stellar products that deliver the best performance with the best technology. And to this day, we live strongly by that belief.

Over a century of innovation.

A. O. Smith enjoys a rich history of achievements. A glimpse at our 144-year history reveals numerous engineering and technical achievements.



1874

The Smith family started a small mechanical shop in Milwaukee, North America.



1906

A. O. Smith was North America's largest automobile frame manufacturer.



1936

A. O. Smith patents the glass-lined water heater.



1995

Reach into the Asian market by entering two joint-ventures in China.

1889

The company enters the bicycle industry.



1927

A. O. Smith was a leading supplier of line pipe.



1954

The water heater division introduces the first glass-lined commercial water heater, the A. O. Smith Burkay® B-65.



2010

State-of-the-art plant set-up in Harohalli, Bengaluru in 2010.





What a purifier.

Our range of water purifiers offer everything you've thought of. And more. Engineered with the finest technologies, our water purifiers are intuitive, efficient and beautiful. Whether it's the top of the line A. O. Smith ProPlanet Series or the under the counter invisible models, you'll find one that best suits your needs.

100% RO, Zero Compromise.

In ordinary purifiers, the water bypasses the RO membrane, increasing the risk of contamination. Our purifiers pass 100% of the water through our patented side stream RO membrane. All of which is further purified with our Silver Charge Membrane Technology (SCMT). Additionally, Min-Tech re-introduces essential minerals like Calcium and Magnesium that would otherwise have been lost. Giving you water that's clean and tasty.

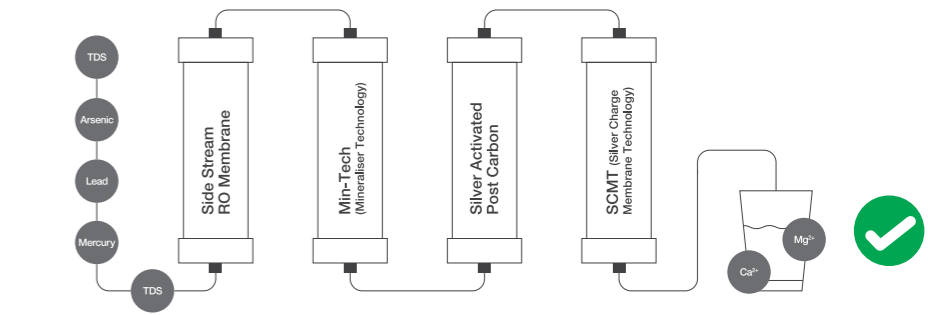

(ZX Double Protection Dual filter: Silver Activated Post Carbon + SCMT)

A. O. Smith vs Ordinary RO + UV

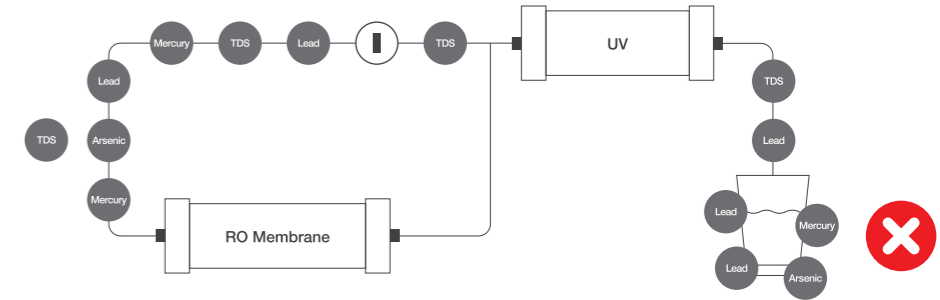

Water bypassing the RO membrane can contain harmful substances like TDS, lead, arsenic, fluoride, pesticides and other chemicals.



8-stage 100% RO+SCMT.

Our 8 stage RO purification system, in ProPlanet undoes what the world has done to water. At the touch of a button, you get water the way it was meant to be. Fresh, clean and so good that even safe for babies*.

1 Pre-Filter

The first step in our filtration process is the advanced Pre-Filter. It removes sediment and other particulate matter.

2 Sediment Filter

The Sediment Filter removes finer sediment and particulate matter. This increases the life of the RO membrane and subsequent filters, resulting in low maintenance costs.

3 Pre-Carbon Filter

The Pre-Carbon Filter removes any unpleasant colour, taste and odour, including chlorine. It ensures that your water is healthy and tastes the way it was meant to.

4 ART™ MAX

(Advance Recovery Technology™)

Unlike other purifiers, our breakthrough Advance Recovery Technology™ recovers 2X more water* when it runs through the purifier, ensuring minimal water wastage. It's good for the environment and good for you.

5 Patented Side Stream Membrane

Our patented side stream RO membrane removes bacteria, viruses, cysts, heavy metals like lead, mercury and arsenic, as well as pesticides and fluorides. The system is designed to ensure 100% of the water passes through the RO membrane and none of it bypasses it so no impurity stands a chance of passing through.

6 Min-Tech (Mineraliser Technology)

Min-Tech adds essential minerals like Calcium and Magnesium back into the water. So the water you get, tastes fresh and natural with a balanced pH level.

7 Silver Activated Post Carbon

The Silver Activated Post Carbon filter is our 7th stage of purification. Ionized silver is a powerful antimicrobial agent. So your water runs through a silver-based filter that prevents any microbial growth. Because impurity should have no place in your drinking water.

8 SCMT

(Silver Charge Membrane Technology)

SCMT prevents any potential secondary microbial contamination post RO purification.

Filtration Technology	SCMT	UF	MF	UV
Virus	✓	✗	✗	✓
Bacteria	✓	✓	✓	✓
Cysts	✓	✓	✓	✓
Particulates	✓	✓	✓	✗
Endotoxins	✓	✓	✓	✗
Colloids	✓	✓	✗	✗
Chemical reduction	✓	✗	✗	✗
Phosphates	✓	✗	✗	✗

*Under standard test condition. ART™ patent applied.
Disclaimer : Product images / color shown may vary from actual model.



proplanet
Series



Instant hotness.

A good-looking machine that dispenses mineralised hot water in an instant. Whether it's for a quick cuppa or instant noodles, you can choose between water at 45°C for drinking or 80°C for cooking. No more waiting for water to bubble over a flame. Simply press a button and it's right there.



ProPlanet series has a water recovery of more than 60%. It is India's 1st and only 5 star rated water purifier in terms of water savings certified by IAPMO (International Association of Plumbing and Mechanical Officials) ProPlanet series water purifiers are compliant to 'IAPMO - I WPSC-01:2019 Evaluation of Point of Use Water Purification System.



Let there be light. Night Assist.

Our ProPlanet P7 and P6 purifiers come with Night Assist. It helps you locate your purifier in the dark without having to switch on the lights.



Support. After sales.

Every A. O. Smith water purifier comes with A. O. Smith's Power of One service#. Simply call our 24x7 helpline and we'll take it forward from there.



1 Hour Response

We will schedule a service appointment within one hour of your call to our customer care number.



1 Day Resolution

A company authorised service technician will visit within 24 hours of your call.



1 Time Fix

Our company authorised service technician will carry and replace any non-working component on the very first visit.



1-Year Warranty

All our ProPlanet series water purifiers come with a 1-year comprehensive warranty* that includes the filter and the patented side stream RO membrane. To give you complete peace of mind.



#For calls registered at A. O. Smith Call Centre before 4 pm only. Available only in selected cities.

*Inclusive of all filters and RO membrane.

Disclaimer : Product images / color shown may vary from actual model.

proplanet

Baby - Safe.*
Earth - Safe.



ProPlanet series is designed for the discerning consumer-both environment conscious and health conscious.

The stylishly crafted ProPlanet water purifiers are equipped with RO + Silver Charged Membrane Technology (SCMT) that gives you 100% RO purified, baby-safe* water, using an 8 stage purification process. The elegant and stylish design of ProPlanet enhances the beauty of your kitchen and also saves 2X more water than an ordinary RO water purifier* making it earth-safe too.

Why Baby-Safe* & Earth-Safe?

Baby-Safe*: ProPlanet series is equipped with RO + Silver Charged Membrane Technology (SCMT) which gives you 100% RO purified, baby-safe* water, by using an 8 stage purification process.

Earth-safe: With its Advance Recovery Technology, ProPlanet ensures that you save 9000L of water annually, which is potentially sufficient to fulfill drinking water requirement of 2 families of 4. Hence, it is India's first 5 star rated water purifier in terms of water saving, making it earth-safe.

With its smart compact design, contemporary looks and cutting-edge features, ProPlanet water purifier goes well with any tastefully-done kitchen interior. This meticulously crafted new-age water purifier helps you save water and do your bit towards a greener environment.

Benefits



Baby-Safe* water with 8 stage purification and double protection of 100% RO+SCMT



Retains natural taste with essential minerals using Alkaline MIN-TECH



Give back to your planet, save 9000L of water** annually through ProPlanet's ART™MAX



All Time Fresh water with in-tank UV purification



Elevate your kitchen décor with sleek, compact and contemporary design



Feel proud about your contribution through Smart Intelli-Display panel



ATF Technology (All Time Fresh)

UV LED in tank ensures
purified water is fresh all time(24x7)

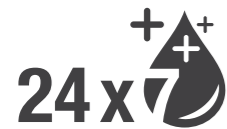

Night Assist

The beautiful night assist light helps you
locate your water purifier at night and
elevates the look of your kitchen.

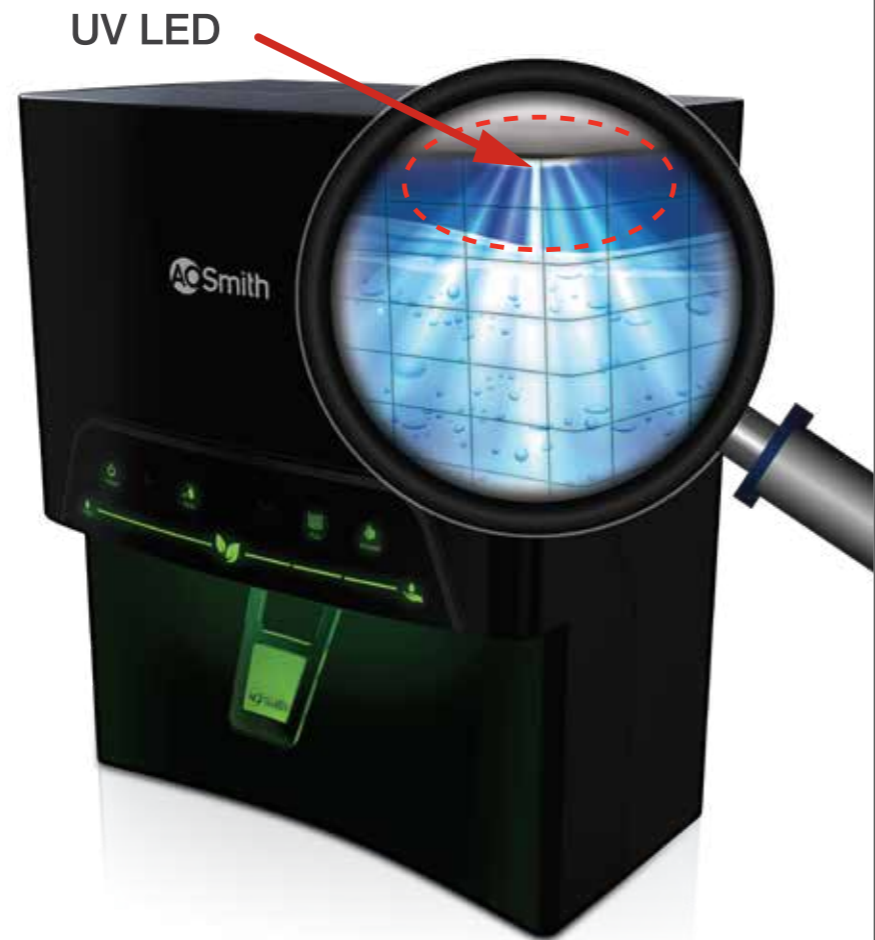

The bar between
Pro-health and Green
Leaf indicator shows the
consumption of
baby-safe* water.

The Green Leaf indicator in the center
glows after completion of each cycle
(~ 10 L) of water saving. This saving helps
you get an idea about the amount of
water saved and hence your contribution
towards the planet.

Each bar between Go
Green and Green Leaf
indicator shows the saving
of more than 3L
of water.**





proplanet

Series

The ProPlanet series is exclusively crafted for discerning consumers, who not only seek the best water purification product proposition but also are environment conscious at the core. ProPlanet series is India's 1st 5 star rated water purifier in terms of water savings (Certified by IAPMO)

A. O. Smith ProPlanet series is a range that gives you healthy water in an eco-friendly way.



Ordinary RO water purifiers use four glasses of water to make just one glass of clean water. But A. O. Smith water purifiers with Advance Recovery Technology™ (ART™) save 2X more water*. With high water recovery of 60% in ProPlanet series, you save more than 9000L of water annually*, which is potentially enough for 2 families of 4. Unlike ordinary RO purifiers, the water doesn't bypass the RO membrane. Instead, we pass 100% of the water through it. What this means is that all the water is purified with minimal wastage.

Features you'll love.

Stands up. Stands out.

Every A. O. Smith water purifier is conveniently designed to either be placed upright on a table or mounted on a wall. Because a true masterpiece will look good anywhere.



Child-Lock Button.

The Child-Lock feature prevents your kids from accidentally starting the flow of hot water and possibly scalding themselves.



Auto Flush.

The Auto Flush notifies you about the purifier flushing out any impurities present within. Consider it detox.



Advance Alert.

The Advance Alert is a handy system that lets you know if the RO membrane or other filters need changing.



Shows it all.

The display on your A. O. Smith RO water purifier provides useful information like water temperature, tank full, filter alerts and power mode in one beautiful digital package.



Drip tray.

The drip tray in your A. O. Smith RO water purifier is super convenient when you want a glass of water and have your hands full. But it's also easy to remove when filling large bottles or vessels.



Healthy water. Maximum capacity.

Every one of our purifiers comes with water storage capacity of up to ten litres. So you'll never run out of clean and healthy water.

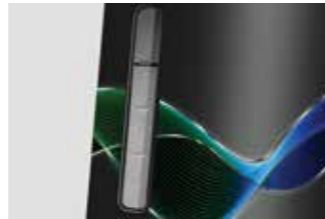

Water level indicator.

The translucent level indicators show you how much water there is. So you don't have to guess.



Food-grade water tank.

Your A. O. Smith RO water purifier is made from virgin food-grade ABS. This ensures no leaching of toxins from the water tank into the water. It keeps your water clean and healthy.

Disclaimer : Product images / color shown may vary from actual model. Design, feature and specifications mentioned are subject to change without notice.



A ray of purity.

The Z1 uses advanced ultraviolet technology to purify your water. UV is a proven non-chemical disinfectant technology that uses UV rays to penetrate bacterial cell walls and destroy them. UV technology is effective on water with low TDS levels.



Ultra-Pure

The Ultrafine and UV technology of X2 gives you water which is pure and tasty. This not only separates extremely fine particles from water but also destroys bacteria present in it. This technology is effective on water with low TDS and hardness levels.



Disclaimer : Product images / color shown may vary from actual model.



Under the counter. Over the top.





A. O. Smith brings international design
for your beautiful kitchen

Imagine getting pure drinking water straight from your kitchen tap. The Z2+ and X5+ are designed specifically to be placed under your kitchen counter. Except for the faucet that comes along with each of them, they stay out of sight and come engineered with the highest standard of Reverse Osmosis Technology. So you get clean and healthy water, every time you turn the tap.

Disclaimer : Product images / color shown may vary from actual model.

100% RO, With MIN-TECH (Mineraliser Technology)

Benefits

-  Healthy drinking water with **6 stages of purification** technology
-  Fits seamlessly with your modern modular kitchen décor with its **Sleek & compact design**
-  Retains **Natural taste** with **essential minerals** using MIN-TECH
-  **Gooseneck faucet** for convenience
-  **1 year comprehensive warranty** (includes RO membrane and filters) or 2 year warranty on RO membrane



INVI-U1
WATER PURIFIER



UV+SAPC Technology

**Untouched. Unseen.
Unbelievable benefits.**

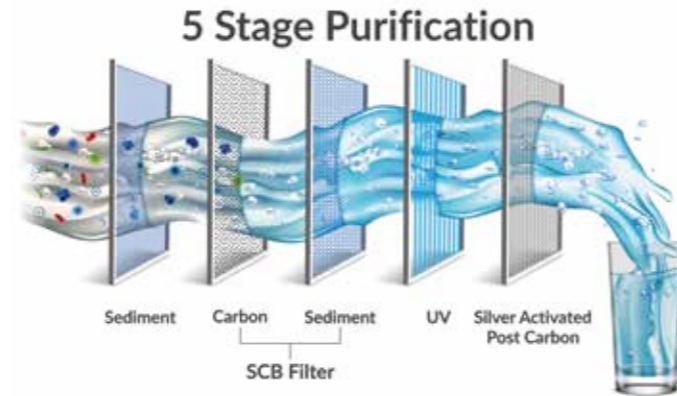

An under-the-counter water purifier with cutting edge features that blends into your kitchen's beauty.



UV+SAPC Technology

Benefits



Healthy and safe water with double protection of UV + SAPC technology.



Purified water with 5 stage purification.



Convenient to use with under the counter placement and gooseneck faucet design.



Fits seamlessly with your modern modular kitchen décor with its Sleek & compact design.

Disclaimer : Product images / color shown may vary from actual model.



MODEL	P7	P6	P4	P3	P5	X3 ⁺
MAIN TECHNOLOGY	RO + SCMT	RO + SCMT	RO + SCMT	RO + SCMT	RO + SCMT	RO + MIN-TECH
100% RO WATER PURIFIER	✓	✓	✓	✓	✓	✓
TOTAL FILTRATION STAGES	8	8	8	8	8	6
Pre-Filter	✓	✓	✓	✓	✓	✗
Sediment Filter	✓	✓	✗	✓	✓	✓
SCB Filter®	✓	✓	Sediment + Carbon Filter	Sediment + Carbon Filter	✓	Sediment + Carbon Filter
ART™MAX (Advance Recovery Technology™)	✓	✓	✓	✓	✓	✗
Side Stream RO Membrane	✓	✓	✓	✓	✓	✓
MIN-TECH (Mineraliser Technology)	✓	✓	Yes, Alkaline Min-Tech	Yes, Alkaline Min-Tech	✓	✓
ZX Double Protection Dual Filter® (Patent Applied)	(SAPC)	✓	✓	✓	✓	✓
	(SCMT)	✓	✓	✓	✓	✗
CONVENIENCE FEATURES						
Storage Capacity (Approx)	10 Ltrs (9.2 Ltrs + 0.8 Ltrs steel hot tank)	10 Ltrs (9.2 Ltrs + 0.8 Ltrs steel hot tank)	5 Ltrs	5 Ltrs	9 Ltrs	5 Ltrs
Water Dispensing Type	Touch	Faucet	Faucet	Faucet	Faucet	Faucet
Hot Water	✓	✓	✗	✗	✗	✗
Child-Lock	✓	✓	✗	✗	✗	✗
Night Assist	✓	✓	✓	✓	✗	✗
Auto Fill	✓	✓	✓	✓	✓	✓
Advance Alert Technology for Filters	✓	✓	✓	✗	✓	✓
Removable Drip Tray	✓	✓	✗	✗	✓	✗
Water Level Indicator	✓	✓	✗	✗	✓	✗
Mounting Options	Wall/Table	Wall/Table	Wall	Wall	Wall/Table	Wall
Display	Digital	Digital	Digital	Digital	Digital	Digital
SPECIFICATIONS						
Dimension (H x D x W) in mm	482 x 369 x 326	482 x 369 x 326	460 x 267 x 380	460 x 267 x 380	490 x 329 x 315	460 x 256 x 380
Pressure rating in psi***	7 ~ 30	7 ~ 30	7 ~ 30	7 ~ 30	7 ~ 30	5 ~ 30
Input Voltage in watt	150 ~ 300V AC / 50 Hz	150 ~ 300V AC / 50 Hz	150 ~ 300V AC / 50 Hz	150 ~ 300V AC / 50 Hz	150 ~ 300V AC / 50 Hz	150 ~ 300V AC / 50 Hz
Power rating watt (Max)	60	60	60	60	48	48
Heating Element in watt	500 @ 230VAC	500 @ 230VAC	Not applicable	Not applicable	Not applicable	Not applicable
UV LED Technology	Not applicable	Not applicable	7mW	Not applicable	Not applicable	Not applicable
% Recovery##	>60%	>60%	>60%	>60%	>60%	Upto 30%
TDS reduction##	≥95% (approx.)	≥95% (approx.)	≥95% (approx.)	≥95% (approx.)	≥95% (approx.)	≥95% (approx.)
Water flow rate	Upto 15 Litres/hour	Upto 15 Litres/hour	Upto 15 Litres/hour	Upto 15 Litres/hour	Upto 15 Litres/hour	15 Litres/hour
Suitable for TDS level	Upto 2000 ppm	Upto 2000 ppm	Upto 2000 ppm	Upto 2000 ppm	Upto 2000 ppm	Upto 2000 ppm
Suitable for hardness level	Upto 500 ppm	Upto 500 ppm	Upto 500 ppm	Upto 500 ppm	Upto 500 ppm	Upto 500 ppm
Storage Tank Material	Food Grade	Food Grade	Food Grade	Food Grade	Food Grade	Food Grade
1-YEAR COMPREHENSIVE WARRANTY	Yes* (including all filters and RO membrane)	Yes* (including all filters and RO membrane)	Yes* (including all filters and RO membrane)	Yes* (including all filters and RO membrane)	Yes* (including all filters and RO membrane)	Yes** and 1 year warranty on RO membrane and 6 months warranty on other filters



MIN-TECH (Mineraliser Technology) | Silver Activated Post Carbon (SAPC) Silver Charged Membrane Technology (SCMT)

*Under standard test condition. For more details refer www.aosmithindia.com
 Input water should have TDS <2000 ppm, in case it exceeds refer to product manual for warranty details. | *For detailed specifications please refer product manual.
 ***If input pressure exceeds 30 psi, a pressure reducing valve needs to be installed at the feed line. If the pressure is lower than 7 psi, a booster pump needs to be installed.
 **Warranty not available on consumables other than RO membrane.
 *1 year if input water has TDS < 2000 ppm. 2 years if input water has TDS < 2000 ppm and hardness < 400 ppm. | *Z1 & X2 model suggested for TDS up to 200 ppm and hardness up to 120 ppm. For more details refer www.aosmithindia.com.
 Product colour and image may vary from the actual product. A. O. Smith reserves the right to amend or modify the specifications and features at any time, as and when required without any prior notification.

MODEL	X3	Z2 ⁺	X5 ⁺	Z1	X2	INVI-U1
MAIN TECHNOLOGY	RO + MIN-TECH	RO + MIN-TECH	RO + MIN-TECH	UV+UF(Ultra Fine)	UV+UF(Ultra Fine)	UV + SAPC
100% RO WATER PURIFIER	✓	✓	✓	Not applicable	Not applicable	Not applicable
TOTAL FILTRATION STAGES	6	6	6	5	5	5
Pre-Filter	✗	✓	✗	✓	✗	✗
Sediment Filter	✓	✓	✓	Fine Sediment	Fine Sediment	✓
Carbon Filter	✗	✓	✓	✓	✓	✗
SCB Filter	Sediment Filter	✓	✗	✓	✓	✓
	Carbon Filter	✓	✗	✗	✗	✓
Side Stream RO Membrane	✓	✓	✓	✗	✗	✗
SCM-TECH® Filter (MIN-TECH + SAPC)	MIN-TECH	✓	✓	✗	✗	✗
	SAPC	✓	✓	✓	✗	✓
UV (Ultraviolet)	✗	✗	✗	✓	✓	✓
UF (Ultra Fine)	✗	✗	✗	✓	✓	✗
CONVENIENCE FEATURES						
Storage Capacity	5 Ltrs	5 Lts	7.5 Ltrs	10 Ltrs	5 Ltrs	Inline
Water Dispensing Type	Faucet	Gooseneck Faucet	Gooseneck Faucet	Faucet	Faucet	Gooseneck Faucet
Hot Water(Heating Element in watt)	✗	✗	✗	✓ (500 @230VAC)	✗	✗
Child-Lock	✗	✗	✗	✓	✗	✗
Night Assist	✗	✗	✗	✓	✗	✗
Advance Alert Technology for Filters	✗	✓	✗	✓	✓	UV Lamp Alert
Tank Full Indicator	✗	✓	✗	✓	✓	✗
Removable Drip Tray	✗	✗	✗	✓	✗	✗
Water Level Indicator	✗	✗	✗	✓	✗	✗
Mounting Options	Wall	Under the Counter	Under the Counter	Wall/Table	Wall	Under the Counter
Display	Not Applicable	Digital	Not applicable	Digital	Digital	Not applicable
SPECIFICATIONS						
Dimension (H x D x W) in mm	460 x 256 x 380	420 x 410 x 270	460 x 205 x 365	482 x 369 x 326	460 x 260 x 380	324 x 230 x 236
Pressure rating in psi***	5 ~ 30	7 ~ 30	7 ~ 30	5 ~ 30	5 ~ 30	5 ~ 30
Input Voltage in watt	150 ~ 300V AC / 50 Hz	150 ~ 300V AC / 50 Hz	150 ~ 300V AC / 50 Hz	150 ~ 300V AC / 50 Hz	150 ~ 300V AC / 50 Hz	150 ~ 300V AC / 50 Hz
Power rating watt (Max)	48	48	48	36	36	36
UV lamp power wattage	Not applicable	Not applicable	Not applicable	11	11	11
% Recovery##	Upto 30%	Upto 30%	Upto 30%	Not applicable	Not applicable	Not applicable
TDS reduction##	≥95% (approx.)	≥95% (approx.)	≥95% (approx.)	Not applicable	Not applicable	Not applicable
Water flow rate	Upto 15 Litres/hour	Upto 15 Litres/hour	Upto 15 Litres/hour	*30 Lts/hr (@15psi feed pressure)	*30 Lts/hr (@25psi feed pressure)	Upto 90L/Hr
Suitable for TDS level	Upto 2000 ppm	Upto 2000 ppm	Upto 2000 ppm	Upto 200 ppm	Upto 200 ppm	Upto 200 ppm
Suitable for hardness level	Upto 500 ppm	Upto 500 ppm	Upto 500 ppm	Upto 120 ppm	Upto 120 ppm	Upto 120 ppm
Storage Tank Material	Food Grade	Food Grade	Food Grade	Food Grade	Food Grade	Food Grade
1-YEAR COMPREHENSIVE WARRANTY	Yes** and 6 months warranty on RO membrane+other filters	Yes and 1 or 2 year warranty for RO membrane	Yes and 1 or 2 year warranty for RO membrane	Yes* on UV lamp and all electrical and functional part, except filters	Yes* on UV lamp and all electrical and functional part, except filters	Yes* on UV lamp and all electrical and functional part, except filters

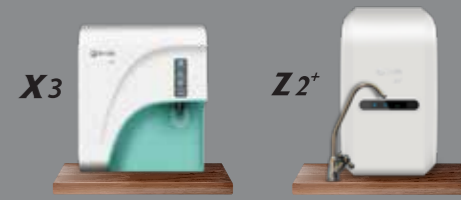

MIN-TECH (Mineraliser Technology) | Silver Activated Post Carbon (SAPC) | Silver Charged Membrane Technology (SCMT)

*Under standard test condition. For more details refer www.aosmithindia.com
 Input water should have TDS <2000 ppm, in case it exceeds refer to product manual for warranty details. | *For detailed specifications please refer product manual.
 ***If input pressure exceeds 30 psi, a pressure reducing valve needs to be installed at the feed line. If the pressure is lower than 7 psi, a booster pump needs to be installed.
 **Warranty not available on consumables other than RO membrane.
 *1 year if input water has TDS < 2000 ppm. 2 years if input water has TDS < 2000 ppm and hardness < 400 ppm. | *Z1 & X2 model suggested for TDS up to 200 ppm and hardness up to 120 ppm. For more details refer www.aosmithindia.com.
 Product colour and image may vary from the actual product. A. O. Smith reserves the right to amend or modify the specifications and features at any time, as and when required without any prior notification.

We've raised the bar.
For water heaters too.



In addition to water purifiers, we've also brought international-standard water heaters to India. Lined with our patented Blue Diamond® Technology, our water heaters are designed to withstand excess sedimentation and pressure fluctuations. Unlike ordinary water heaters we've engineered ours to not just match the bar set by Indian regulation authorities, but far exceed it. In addition, we've also put in place a wide network of specially trained engineers, so you get the same level of after sales service you'd expect from A. O. Smith. Things really are heating up in India's water heater industry.

Disclaimer : Product images / color shown may vary from actual model.